



### SUN

Effective shade structure with UPF 50+ Protection from harmful UV radiation.



### WIND

25 mph sustained wind protection. Up to 40 mph gusts.\*

\*depending on model & anchoring



### RAIN

100% Waterproof. Your tent can even float on water.

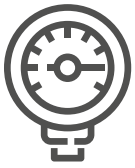

### FAST & EASY

Up within minutes. Easy Up - Easy Down 1 person assembly.



### LIGHTWEIGHT

Backpack carry bag included. Starting under 28 lbs.



### SAFE & DURABLE

No pinched fingers. No broken poles.

The Airemos Endeavor has six optional panels. Each can be printed in full color and may be printed in full bleed or spot printed on every surface.

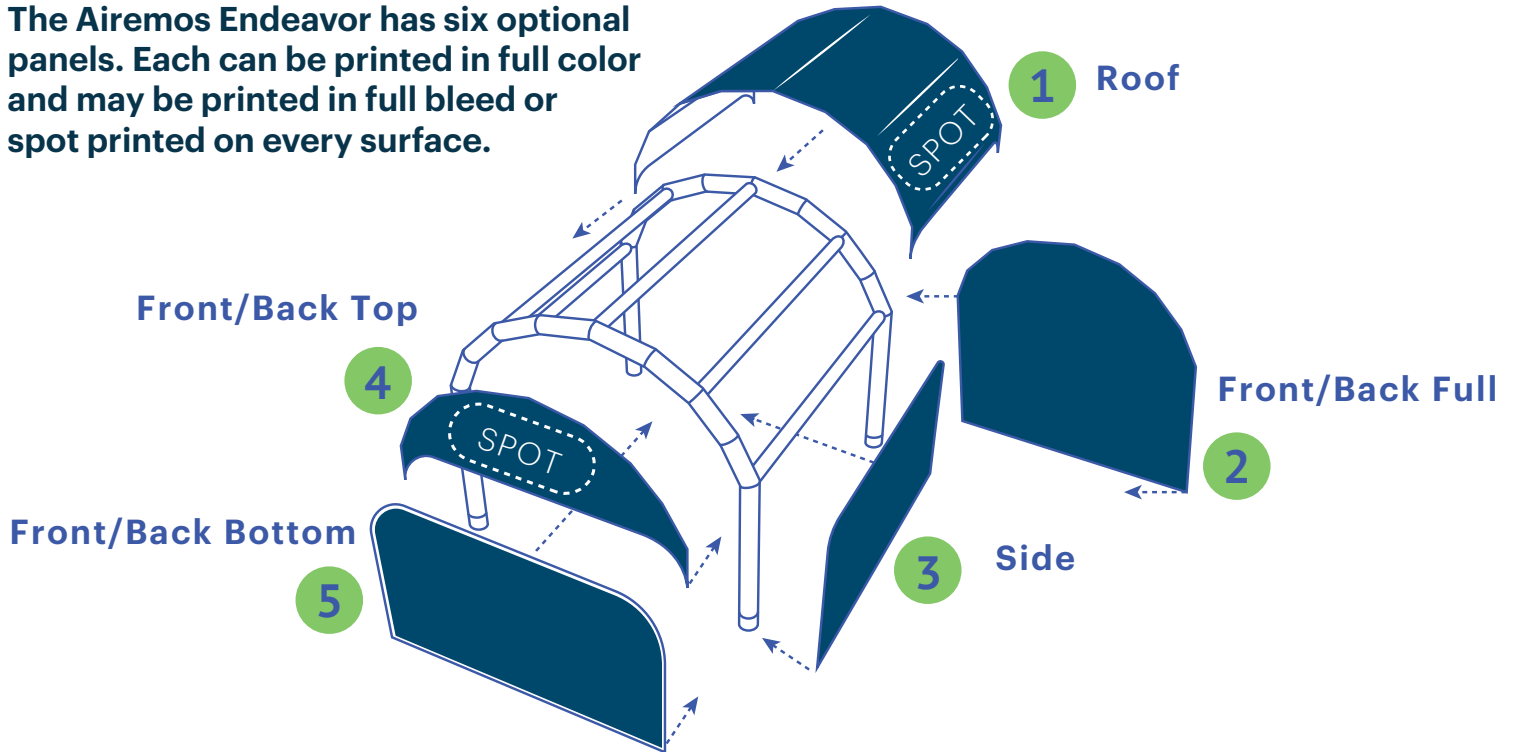

### framings colors



### roof & siding

SPF 50+ / Fire Retardant

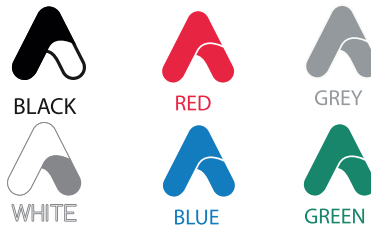

### printing

- Dye Sublimation (White substrate only)
- Heat Transfer (Dark and White substrates)
- Screen (White substrate only)
- Digital (White substrate only)

### links systems

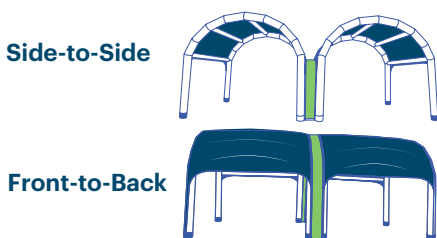

### inflators

120v Electric Pump

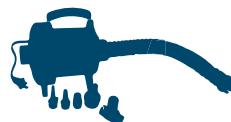

3-min Inflation

12v Battery Pump



5-min Inflation

### anchoring

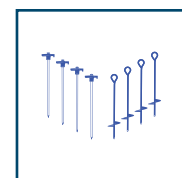

Ground Stakes (4x)

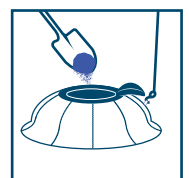

Sand Ballasts (4x)

Airemos offers a Lifetime Service Agreement. Contact your representative for full details.